



BLIN MACHINERY

CHINESE TECHNOLOGY

FLAT BED CNC LATHE
CNC PIPE THREADING LATHE
CONVENTIONAL LATHE



2021A

www.blincnc.com
NINGBO BLIN MACHINERY CO.,LTD.

NINGBO BLIN MACHINERY CO.,LTD.

Export sales center: No.415 Zhenhai Avenue, Luotuo, Zhenhai District, Ningbo, China. P.C.:315202
Tel:+86-574-87176990 / 87579510 / 86571950 Fax:+86-574-87179916
Email: jmmny@blinmachinery.com
www.blincnc.com



Machines' design and specification are subjected to update without notice

History

Our advantages:

www.blincnc.com



LINEAR-GUIDEWAY FLAT BED CNC LATHE

Z0632	01/02
LINEAR guideway, Economical,576" collet/chuck, Gang tool,without taillock	

BOX-GUIDEWAY FLAT BED CNC LATHE

• CK SHORT SERIES	
CK6132	03/04
350mm guideway width,spindle bore:50mm	
• TK PRECISE SERIES	
TK36S/EK40	05/06
316mm guideway width, spindle bore:57mm, CHINA top quality	
• CK LIGHT-DUTY SERIES	
CK6136/6140	07/08
312mm guideway width,spindle bore: 52mm	
• SK PRECISE SERIES	
SK40S/50S/66Q	09/10
390mm guideway width,spindle bore: 77/82/105mm, CHINA top quality	
• TK PRECISE SERIES	
TK50	11/12
390mm guideway width,spindle bore: 87mm, CHINA top quality	
• CAK STANDARD SERIES	
CAK6140/6150/6161/6166/6180	13/14
400mm guideway width,spindle bore:52/80/104mm	
• HK PRECISE HEAVY-DUTY SERIES	
HK63B/80B	15/16
560mm guideway width,spindle bore:105mm,CHINA top quality	
• HK PRECISE HEAVY-DUTY SERIES	
HK80/100	17/18
650/755mm guideway width,spindle bore:105/130mm,CHINA top quality	
• CKL STANDARD SERIES	
CKL6163/6180A/6180B/61100	19/20
550/600mm guideway width,spindle bore:104mm	
• CK HEAVY-DUTY SERIES	
CK61100/61125/61140/61160	21/22
755mm guideway width,spindle bore:130mm	
• CKW HEAVY-DUTY SERIES	
CKW61125/61140/61160/61180/61200	23/24
1100mm guideway width,spindle bore:100mm	

CNC PIPE THREADING LATHE

• QK STANDARD SERIES	
QK1313/1319/1322/1325/1327A	25/26
550/600mm guideway width,spindle bore:130/200/225/255/280mm, high quality	
• QK HEAVY-DUTY SERIES	
QK1327B/1332/1338/1343/1350/1363	27/28
755/1100mm guideway width,spindle bore:280/330/390/440/520/640mm, high quality	

CONVENTIONAL LATHE

• B PRECISE HEAVY-DUTY SERIES	
HL-B40/50/66/80	29/30
390mm guideway width,CHINA top quality	
HL-B63B/80A	31/32
560mm guideway width, CHINA top quality	

MODEL INDEX



FLAT BED CNC LATHE
BL-Z0632

LINEAR GUIDEWAY, ECONOMICAL, 5 7/16" COLLET/CHUCK, GANG TOOL, WITHOUT TAILTOCK

BLIN Ideal for machinery solution



Features:

- TAIWAN linear guideway and ball screw
- Super high performance-price ratio

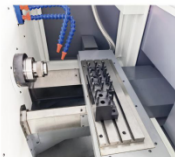

Own-made collet with gang tool



TAIWAN CL Collet chuck(opt.)



SCHNEIDER electricity parts



GSK980TC3

Specification:

Item	Specification	Unit	BL-Z0632
Capacity	Chuck size	/	5 7/16"
	Max. swing dia. over bed	mm	Φ400
	Max. swing dia. over slide	mm	Φ120
	Max. turning length	mm	200(chuck)
Spindle	Spindle speed	rpm	3000
	Spindle type	/	A2-5
	Spindle bore	mm	Φ48
	Spindle motor	kw	3
	Clamping device	/	Hydraulic collet/Hydraulic chuck
X/Z axes	X/Z axes travel	mm	320/330
	X/Z axes servo motor	N/m	4/4
	X/Z axes rapid move speed	m/min	20/20
	X/Z ball screw O.D.	mm	Φ25/Φ32
	X/Z linear guideway width	mm	25/30
	X/Z axes positioning accuracy	mm	0.03/0.03
	X/Z repeatability accuracy	mm	0.005/0.01
Tool post	Tool post	/	Gang tool/4T tool turret
	Toolshank size	mm	20×20
Tailstock	Tailstock	/	N/A
Others	Overall size	mm	1700×1400×1700
	N.W.	kg	1200

Main parts list:

Item	Brand
Bearings	CHINA top
Ball screw	TAIWAN
Linear guideway	TAIWAN
Chuck& cylinder	TAIWAN-AUTOGRIP
Main electric parts	FRANCE-SCHNEIDER

Standard configuration:

- GSK980TC3 CNC Controller
- Hydraulic collet
- Gang tool

Optional configuration:

- SIEMENS 808D ADVANCED CNC controller
- Hydraulic chuck
- 4 station tool turret



FLAT BED CNC LATHE CK SHORT SERIES BL-CK6132

350MM GUIDEWAY WIDTH, SPINDLE BORE: 50MM

BLIN Ideal for machinery solution



Features:

- Wide guideway and big ball screw, good rigidity
- Ball screw mount at middle of guideway and connect with motor directly, drag force is equal, small friction
- Guideway and ball screw full enclosed



Bridge shape spindle



Strong guideway middle set ball screw

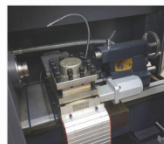

Collet and 4 station tool turret



Chuck and 8 station tool turret

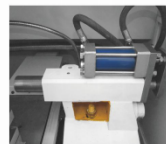

Hydraulic tailstock

Specification:			
Item	Specification	Unit	BL-CK6132
Capacity	Guideway width	mm	350
	Max. swing dia. over bed	mm	Φ320
	Max. swing dia. over slide	mm	Φ160
Spindle	Spindle speed range	rpm	200-2500
	Spindle bore	mm	Φ50
	Spindle nose	/	A2-5
	Spindle motor power	kw	5.5
	Spindle bearings(front+back)	pcs	3+2
X/Z axes	X/Z axes travel	mm	260/450
	X/Z axes feeding speed	m/min	8/8
	Finish turning accuracy	mm	±0.01
	X/Z axes repeatability	mm	0.01
	Slide board size	mm	185×380
	X axes ball screw dia./pitch	mm	25/4
	Z axes ball screw dia./pitch	mm	40/6
Tailstock	X/Z axes motor	N.m	4/6
	Tailstock quill dia./travel	mm	Φ58/130
Tool post	Tailstock quill taper	/	MT4#
	Tool turret type	/	Vertical 4T/gang tool/Horizontal 6,8T
Others	Tool shanksize	mm	24×24
	Overall size(L×W×H)	mm	1810×1160×1600
	N.W.	kg	1600

Main parts list:

Item	Brand
Bearing	China top-HRB P4 class
Ball screw	China top
Spindle lipid	US SHELL
Contactar	SIEMENS OEM
Pneumatic parts	TAIWAN-AIRTAC
Electricity parts	China top
linkager	JAPAN
Hydraulic parts	TAIWAN

Standard configuration:

- SIEMENS 808D ADVANCED CNC controller
- Manual chuck
- 4 station tool post
- Manual tailstock

Optional configuration:

- Hydraulic chuck
- Gang tool, 6,8 station tool turret
- Hydraulic tailstock



FLAT BED CNC LATHE TK PRECISE SERIES BL-TK36S/EK40

316MM GUIDEWAY WIDTH, SPINDLE BORE:57MM, CHINA TOP QUALITY

BLIN Ideal for machinery solution



Features:

- Adopt China best high strength compound resin sand cast iron
- Aging treatment has good vibration absorption and rigidity
- Adopt independent spindle.3000rpm high speed, especially suitable for nonferrous metal processing
- Spindle unit adopt precise angle contact ball bearing and double column cylindrical roller bearings
- Guideway hardened by ultrasonic frequency and precise ground, good precision keeping
- Guideway stick PTFE,remove creeping,obviously increase precision, wearability and anti-impact force
- Adopt independent coolant tank design

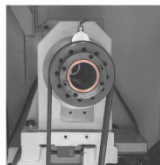

Independent spindle



Machine inside



Electricity cabinet



SIEMENS 808D ADVANCED

Specification:				
Item	Specification	Unit	BL-TK36S	BL-EK40
Capacity	Guideway width	mm	316	
	Max. swing dia. over bed	mm	Φ360	Φ400
	Max. swing dia. over slide	mm	Φ180	Φ200
	Max. turning dia.	mm	Φ320(vertical 4T tool turret); Φ220(horizontal 6T tool turret)	Φ400
	Center distance	mm	750/690/650 (vertical 4T/horizontal 6 T tool turret/ Φ75mm tailstock quill)	750/1000
Spindle	Max turning length	mm	600/540/500 (vertical 4T/horizontal 6 T tool turret/ Φ75mm tailstock quill)	580/830
	Max. workpiece weight	kg	550(8" manual chuck)	
Spindle	Spindle bore	mm	Φ57	
	Spindle head type	/	ISO702/I A2-6(manual chuck, 8" hydraulic chuck); ISO702/I A2-5(6" hydraulic chuck)	
	Spindle speed	rpm	140-3000(stepless)	
	Spindle motor	kw	5.5(servomotor)	
	Chuck size	/	8"	
X/Z axes	X axes travel	mm	200/150 (vertical 4T/horizontal 6T tool turret)	230
	Z axes travel	mm	610/550/510 (vertical 4T/horizontal 6 T tool turret/ Φ75mm tailstock quill)	590/840
	X/Z axes rapid speed	m/min	6/8	
	X,Z axes ball screw O.D/pitch	mm	Φ25/5,Φ40/6	
Tool post	Tool turret type	/	Vertical 4/Horizontal 6 station/gang tool	
	Tool shank size	mm	20×20,Φ32	
Tailstock	Tailstock quill dia./travel	mm	Φ55/120(hydraulic tailstock: 100); Φ75/150(hydraulic tailstock:130)	Φ65/120
	Tailstock quill taper	/	MT4#/MT5#(Φ75mm tailstock quill)	
	X/Z axes positioning accuracy	mm	0.026/0.032	0.026/0.032(750mm); 0.036(1000mm)
Accuracy	X/Z axes repeatability positioning accuracy	mm	0.007/0.009	0.007/0.009(750mm); 0.011(1000mm)
	Turning workpiece roundness	mm	0.004	
	Total power	KVA	12	
Others	N.W.	kg	1700	1700(750)/2100(1000)
	Overall size(L×W×H)	mm	2150×1260×1600	2150×1260×1600(750mm) 2400×1260×1600(1000mm)

* The marked accuracy just follows CHINA national standard GB/T 25659.1, actual accuracy is much higher

Main parts list:		Standard configuration:	Optional configuration:
Item	Brand	•FANUC Oi TF CNC Controller •Manual chuck •4 station tool post •Manual tailstock	•SIEMENS 808D/GSK980TDI •Hydraulic chuck •6 station tool turret •Hydraulic tailstock
Spindle bearing	CHINA top-CSC/ZWZ		
Ball screw bearing	CHINA top-CSC		
Ball screw	CHINA top		
Lubrication pump	JAPAN-HERG		



FLAT BED CNC LATHE CK LIGHT-DUTY SERIES BL-CK6136/6140

312MM GUIDEWAY WIDTH, SPINDLE BORE: 52MM

BLIN Ideal for machinery solution



Features:

- Guideway width 312mm, suitable for light process
- Can choose Independent spindle or 2 class gear spindle
- Bed casted by China top quality compound resin sand cast iron
- Guideway hardened by ultrasonic frequency, good precision keeping
- Aging treatment, has good vibration absorption and rigidity
- Guideway stick PTFE, remove creeping, obviously increase precision, wearability and anti-impact force
- Spindle use high precision bearing, Germany KLUBER lipid
- High precision ball screw, connected with motor directly



Gear spindle



312mm guideway width



6.8 station tool turret(opt.)



SCHNEIDER electricity parts



SIEMENS 808D ADVANCED

Specification:				
Item	Specification	Unit	BL-CK6136	BL-CK6140
Capacity	Guideway width	mm	312	
	Max. swing dia. over bed	mm	Φ360	Φ400
	Max. swing dia. over slide	mm	Φ200	Φ240
	Max. workpiece length	mm	750/1000	
Spindle	Spindle bore	mm	Φ52	
	Spindle taper	/	MT6#	
	Spindle speed	rpm	Independent spindle:100-1600; 2 class gears:25-1600(66-660,65-1600) 2 class gears:100-3000(100-1047,290-3000)	
	Spindle head type	/	C6	
	Chuck size	/	8"	
	Spindle motor	kw	5.5	
	X axes travel	mm	210	
	Z axes travel	mm	600/850	
X/Z axes	X/Z axes ball screw O.D.	mm	20/40	
	X/Z axes rapid rate	m/min	4/6	
	X/Z axes positioning accuracy	mm	±0.015	
	X/Z axes repositioning accuracy	mm	±0.006	
Tool post	Tool post	/	Vertical 4T/Horizontal 6,8T	
	Toolshank size	mm	20×20	
Tailstock	Tailstock quill travel	mm	100	
	Tailstock quill dia.	/	Φ60	
	Tailstock quill taper	/	MT4#	
Accuracy	Turning accuracy	/	IT6-7	
	Turning roughness	μm	Ra1.6	
	Turning roundness	mm	0.005	
	Turning flatness	mm	0.025/300	
Others	Overall size	mm	2150/2450×1350×1700	1600/1700
	Weight	Kg	1300/1400	1600/1700

Main parts list:

Item	Brand
Bearing	CHINA top-HRB
Ball screw	CHINA top
Spindle	Own-made
Hydraulic parts	TAIWAN
Electricity parts	FRANCE-SCHNEIDER

Standard configuration:

- GSK controller
- Manual chuck
- 4 station tool post
- Manual tailstock

Optional configuration:

- SIEMENS 808D ADVANCED/FANUC 0i TF controller
- Hydraulic chuck
- 6/8 station tool turret
- Hydraulic tailstock



FLAT BED CNC LATHE SK PRECISE SERIES

BL-SK40S/50S/66Q

390MM GUIDEWAY WIDTH, SPINDLE BORE: 77/82/105MM, CHINA TOP QUALITY



Features:

- Adopt China best high strength compound resin sand cast iron
- Two times aging treatment, has good vibration absorption and rigidity
- Guideway hardened by ultrasonic frequency and precise ground, good precision keeping
- Guideway stick PTFE, remove creeping, obviously increase precision, wearability and anti-impact force
- Spindle use high precision bearing
- Adopt manual 3 class integral gear box type spindle, high rigidity, suitable for heavy turning



Machine Frame



Manual 3 class gear spindle

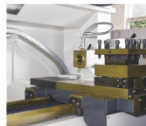

4 station tool turret



Strong tailstock



GSK980TDi

BLIN Ideal for machinery solution

Specification:					
Item	Specification	Unit	BL-SK40S	BL-SK50S	BL-SK66Q
Capacity	Guideway width	mm	390		
	Max. swing dia. over bed	mm	Φ400	Φ500	Φ660
	Max. swing dia. over slide	mm	Φ200	Φ280	Φ440
	Max. turning dia. (vertical 4T/horizontal 6T tool turret)	mm	Φ400/350	Φ500/350	Φ550/350
	Max. workpiece length (vertical 4T/horizontal 6 T tool turret)	mm	710/620; 960/870; 1460/1370; 1960/1870; 2960/2870(for SK40S/50S)		
	Max turning length (vertical 4T/horizontal 6 T tool turret)	mm	570/500; 820/750; 1320/1250; 1820/1750; 2820/2750(for SK40S/50S)		
Spindle	Max. workpiece weight	kg	700(10" manual chuck); 550(8" hydraulic chuck); 700(10" hydraulic chuck);		
	Spindle bore	mm	Φ77(opt. 82, 105)		
	Spindle head type	/	ISO702/ I A2-8(opt. D8)		
	Spindle taper hole	/	Metric 1:20		
	Spindle speed	rpm	3 class gears H:162-1620 M:66-660 L:21-210		
	Spindle motor	kw	7.5(servo)		
X/Z axes	Spindle max. output torque	Nm	800		
	Chuck size	/	10"		
	X axes travel(vertical 4T/horizontal 6T tool turret)	mm	275/235		
	Z axes travel	mm	600/850/1350/1850/2850(for SK40S/50S)		
	X/Z axes rapid speed	m/min	6/8		
	X axes ball screw O.D./pitch	mm	Φ25/5		
Tool post	Z axes ball screw O.D./pitch	mm	Φ40/6(750, 1000, 1500mm); Φ50/6(2000mm); Φ63/8(3000mm)		
	Tool turret type	/	Vertical 4/Horizontal 6 station		
	Tool shank size	mm	25×25		
	Tailstock quill dia.	mm	Φ75(hydraulic tailstock: Φ80)		
Tailstock	Tailstock quill travel	mm	150(hydraulic tailstock: 130)		
	Tailstock quill taper	/	MT5#		
Accuracy	X/Z axes positioning accuracy	mm	0.026/0.032(750mm), 0.036(1000mm), 0.040(1500, 2000, 3000mm)		
	X/Z axes repeatability positioning accuracy	mm	0.007/0.009(750mm), 0.011(1000mm), 0.014(1500, 2000, 3000mm)		
	Turning workpiece roundness	mm	0.004		
Others	N.W.	kg	2050/2100/2150/2200/3500		2150/2200/2250/2300
	Overall size(L×W×H)	mm	2450/2700/3200/3700/4700×1500×1700		2450/2700/3200/3700×1500×1700

* The marked accuracy just follows CHINA national standard GB/T 25659.1, actual accuracy is much higher

Main parts list:		Standard configuration:	Optional configuration:
Item	Brand	<ul style="list-style-type: none"> •FANUC Oi TF CNC Controller •Manual chuck •4 station tool post •Manual tailstock 	<ul style="list-style-type: none"> •SIEMENS 808D/GSK980TDI •Hydraulic chuck •6 station tool turret •Hydraulic tailstock
Spindle bearing	CHINA top-CSC/ZWZ		
Ball screw bearing	CHINA top-CSC		
Ball screw	CHINA top		
Lubrication pump	JAPAN-LUBE		



FLAT BED CNC LATHE TK PRECISE SERIES BL-TK50

390MM GUIDEWAY WIDTH, SPINDLE BORE: 87MM, CHINA TOP QUALITY

BLIN Ideal for machinery solution



Features:

- Adopt China best high strength compound resin sand cast iron
- Times aging treatment, has good vibration absorption and rigidity
- Guideway hardened by ultrasonic frequency and precise ground, after scrapping, good precision keeping
- Guideway stick PTFE, remove creeping, obviously increase precision, wearability and anti-impact force
- Spindle use high precision bearing
- Adopt independent spindle, servo spindle motor

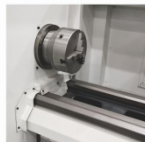

Precise guideway



Independent spindle



4 station tool turret



Strong tailstock



GSK980TDI

Specification:

Item	Specification	Unit	BL-TK50
Capacity	Guideway width	mm	390
	Max. swing dia. over bed	mm	Φ500
	Max. swing dia. over slide	mm	Φ280
	Max. turning dia.(vertical 4T/horizontal 6T tool turret)	mm	Φ500/350
	Max. workpiece length	mm	1100/1600/2100/3100
	Max. turning length	mm	1000/1500/2000/3000
Spindle	Max. workpiece weight	kg	700(10" manual chuck)
	Spindle bore	mm	Φ87
	Spindle head type	/	ISO702/ I A2-8
	Spindle taper hole	/	Metric 1:20
	Spindle speed	rpm	30-2500
	Spindle motor	kw	15(servo)
	Spindle max. output torque	Nm	354
X/Z axes	Chuck size	/	10"
	X axes travel(vertical 4T/horizontal 6T tool turret)	mm	275/235
	Z axes travel	mm	1000/1500/2000/3000
	X/Z axes rapid speed	m/min	6/8
Tool post	X/Z axes ball screw O.D./pitch	mm	Φ25/5, Φ40/6
	Tool turret type	/	Vertical 4/Horizontal 6 station
	Tool shank size	mm	25×25
Tailstock	Tailstock quill dia.	mm	Φ75(hydraulic tailstock: Φ80)
	Tailstock quill travel	mm	150(hydraulic tailstock: 130)
	Tailstock quill taper	/	MT5#
Accuracy	X/Z axes positioning accuracy	mm	0.026/0.036(1000),0.040(1500,2000,3000)
	X/Z axes repeatability positioning accuracy	mm	0.007/0.011(1000),0.014(1500,2000/3000)
	Turning workpiece roundness	mm	0.004
Others	N/W	kg	2800/3200/3600/4600
	Overall size(L×W×H)	mm	2700/3200/3700/4700×1500×1700

* The marked accuracy just follows CHINA national standard GB/T 25659.1, actual accuracy is much higher

Main parts list:

Item	Brand
Spindle bearing	CHINA top-CSC/ZWZ
Ball screw bearing	CHINA top-CSC
Ball screw	CHINA top
Lubrication pump	JAPAN-LUBE

Standard configuration:

- FANUC 0i TF CNC Controller
- Manual chuck
- 4 station tool post
- Manual tailstock

Optional configuration:

- SIEMENS 808D/GSK980TDI
- Hydraulic chuck
- 6 station tool turret
- Hydraulic tailstock



FLAT BED CNC LATHE CAK STANDARD SERIES

BL-CAK6140/6150/6161/6166/6180

400MM GUIDEWAY WIDTH, SPINDLE BORE: 52/80/104MM

BLIN Ideal for machinery solution



Features:

- Guideway width 400mm, suitable for heavy cutting
- Can choose Independent spindle or 3 class gear spindle
- Can choose 52mm, 80mm, 104mm spindle bore
- Bed casted by China best compound resin sand cast iron
- Guideway hardened by ultrasonic frequency, good precision keeping
- Aging treatment, has good vibration absorption and rigidity
- Guideway stick PTFE, remove creeping, obviously increase precision, wearability and anti-impact force
- Spindle use high precision bearing, Germany KLUBER lipid
- High precision ball screw, connected with motor directly



3 class gear spindle



Independent spindle

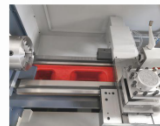

4 station tool turret



8 station tool turret



SCHNEIDER electricity parts

Specification:							
Item	Item	Unit	BL-CAK6140	BL-CAK6150	BL-CAK6161	BL-CAK6166	BL-CAK6180
Capacity	Guideway width	mm	400				
	Max. swing dia. over bed	mm	Φ400	Φ500	Φ610	Φ660	Φ800
	Max. swing dia. over slide	mm	Φ210	Φ280	Φ370	Φ400	Φ540
	Center distance	mm	750/1000/1500/2000/3000				
Spindle	Max. workpiece weight	kg	300				
	Spindle bore	mm	Φ52(Opt.:Φ80/Φ104)				
	Spindle taper	/	MT6#(spindle bore Φ52); Φ90 1:20(spindle bore Φ80); Φ113 1:20(spindle bore Φ104)				
	Spindle speed	rpm	Independent spindle: 100~1600, 3 class gears: 21~150, 66~500, 162~1500				
X/Z axes	Spindle head type		C6(spindle bore Φ52); DB(spindle bore Φ80, Φ104)				
	Chuck size	/	8"/10"				
	Spindle motor	kw	7.5		11		
	X axes travel	mm	250	260	320	340	410
Tool post	Z axes travel	mm	600/850/1350/1850/2850				
	X/Z axes ball screw O.D.	mm	25/50				
	X/Z axes positioning accuracy	mm	±0.015				
	X/Z axes repositioning accuracy	mm	±0.006				
Tailstock	X/Z axes rapid rate	m/min	4/6				
	Tool post type	/	Vertical 4T/Horizontal 6,8T				
Accuracy	Toolshank size	mm	25×25				
	Tailstock quill travel	mm	150				
	Tailstock quill dia.	mm	Φ75				
	Tailstock quill taper	/	MT5#				
Others	Turning accuracy	/	IT6-7				
	Turning roughness	μm	Ra1.6				
	Turning roundness	mm	0.005				
Others	Turning flatness	mm	0.025/300				
	Overall size	mm	2450/2700/3200/3700/4700× 1600×1800		2500/2750/3250/3750/4750× 1650×1900		
	Net weight	kg	2100/2200/2300/ 2700/3500	2200/2300/2400/ 2800/3600	2250/2400/2600/ 2850/3650	2300/2450/2650/ 2900/3700	2400/2550/2750/ 3000/3800

Main parts list:

Item	Brand
Bearing	CHINA top-HRB
Spindle	Own-made
Ball screw	CHINA TOP
Hydraulic parts	TAIWAN
Electricity parts	FRANCE-SCHNEIDER

Standard configuration:

- GSK980TC3 controller
- Manual chuck
- 4 station tool post
- Manual tailstock

Optional configuration:

- SIEMENS 808D ADVANCED/FANUC 0i TF controller
- Hydraulic chuck
- 6/8 station tool turret
- Hydraulic tailstock



FLAT BED CNC LATHE HK PRECISE HEAVY-DUTY SERIES BL-HK63B/80B

560MM GUIDEWAY WIDTH, SPINDLE BORE:105MM, CHINA TOP QUALITY

BLIN Ideal for machinery solution



Features:

- Adopt China best high strength compound resin sand cast iron
- Aging treatment, has good vibration absorption and rigidity
- Guideway hardened by ultrasonic frequency and precise ground, good precision keeping
- Guideway stick PTFE, remove creeping, obviously increase precision, wearability and anti-impact force
- Adopt 3 class integral gear box type spindle, big bore, high rigidity, suitable for heavy turning



Frame



3 class gear spindle



560mm guideway



4 station tool turret

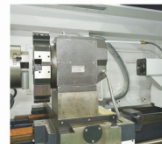

6 station tool turret

Specification:				
Item	Specification	Unit	BL-HK63B	BL-HK80B
Capacity	Guideway width	mm	560	
	Max. swing dia. over bed	mm	Φ630	Φ800
	Max. swing dia. over slide	mm	Φ360	Φ500
	Max. turning dia. (vertical 4T/horizontal 6T tool turret)	mm	Φ630/500	Φ740/610
Spindle	Center distance	mm	1000/1500/2000/3000(vertical 4T tool turret) 900/1400/1900/2900(horizontal 6T tool turret)	
	Max. workpiece weight	kg	1200(standard);1500(max.)	
	Spindle bore	mm	Φ105	
	Spindle head type	/	A1-11	
X/Z axes	Spindle speed	rpm	3 class gears H:112~1120 M:37~373 L:20~210	
	Spindle motor	kw	11(servo)	
	Spindle max. torque	Nm	1265	
	Chuck size	/	Φ315(manual 3-jaw chuck)	
Tool post	X axes travel	mm	370	390
	Z axes travel	mm	760/1310/1810/2810(vertical 4T tool turret) 660/1210/1710/2710(horizontal 6T tool turret)	
	X/Z axes motor	kw	1.4/2.5(FANUC)	
	X/Z axes rapid speed	m/min	6/7	
	X axes ball screw O.D./pitch	mm	Φ40/5	
	Z axes ball screw O.D./pitch	mm	Φ50/8(1000,1500mm);Φ63/8(2000,3000mm)	
Tailstock	Tool turret type	/	Vertical 4/Horizontal 6 station	
	Tool shank size	mm	32×32,Φ32	
	Tailstock quill dia.	mm	Φ100	
Accuracy	Tailstock quill travel	mm	250(150 for hydraulic tailstock&6 station tool turret)	
	Tailstock quill taper	/	MT5#	
	X/Z axes positioning accuracy	mm	0.026/0.032(1000),0.040(1500,2000,3000)	
	X/Z axes repeatability positioning accuracy	mm	0.007/0.009(1000),0.014(1500,2000,3000)	
Others	Turning workpiece roundness	mm	0.004	
	Total power	KVA	30	
	N.W.	kg	4600/5100/5600/6100	4800/5300/5800/6400
Overall size(L×W×H)	mm	3550/4000/4500/5600×2000×1850	3700/4100/5000/5600×2000×2000	

* The marked accuracy just follows CHINA national standard GB/T 25659.1, actual accuracy is much higher

Main parts list:	Standard configuration:	Optional configuration:										
<table border="1"> <thead> <tr> <th>Item</th> <th>Brand</th> </tr> </thead> <tbody> <tr> <td>Spindle bearing</td> <td>CHINA top-CSC/ZWZ</td> </tr> <tr> <td>Ball screw bearing</td> <td>CHINA top-CSC</td> </tr> <tr> <td>Ball screw</td> <td>CHINA top</td> </tr> <tr> <td>Lubrication pump</td> <td>JAPAN-LUBE</td> </tr> </tbody> </table>	Item	Brand	Spindle bearing	CHINA top-CSC/ZWZ	Ball screw bearing	CHINA top-CSC	Ball screw	CHINA top	Lubrication pump	JAPAN-LUBE	<ul style="list-style-type: none"> ●FANUC Oi TF CNC Controller ●Manual chuck ●4 station tool post ●Manual tailstock 	<ul style="list-style-type: none"> ●SIEMENS 808D/GSK980TDI ●Hydraulic chuck ●6 station tool turret ●Hydraulic tailstock ●Steady rest ●Follow rest
Item	Brand											
Spindle bearing	CHINA top-CSC/ZWZ											
Ball screw bearing	CHINA top-CSC											
Ball screw	CHINA top											
Lubrication pump	JAPAN-LUBE											



FLAT BED CNC LATHE **HK** PRECISE HEAVY-DUTY SERIES BL-HK80/100

650/755MM GUIDEWAY WIDTH, SPINDLE BORE:105/130MM, CHINA TOP QUALITY

BLIN Ideal for machinery solution



Features:

- Adopt China best high strength compound resin sand cast iron
- Adopt mono-block floor type bed, super high rigidity
- Aging treatment, has good vibration absorption and rigidity
- Guideway hardened by ultrasonic frequency and precise ground, good precision keeping
- Guideway stick PTFE, remove creeping, obviously increase precision, wearability and anti-impact force
- Adopt 4 class integral gear box type spindle, big bore, high rigidity, suitable for heavy turning
- Hydraulic type Automatic class switch

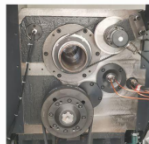

Hydraulic gear spindle

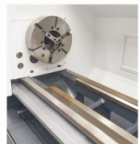

Strong guideway



4 station tool turret

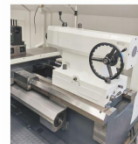

Strong tailstock



Follow rest

Specification:					
Item	Specification	Unit	BL-HK80	BL-HK100	
Capacity	Guideway width	mm	650	755	
	Max. swing dia. over bed	mm	Φ800	Φ1040	
	Max. swing dia. over slide	mm	Φ480	Φ650	
	Max. turning length	mm	/	1300/2800	
	Center distance	mm	1000/1500/2000/3000/4000	1500/3000	
Spindle	Spindle bore	mm	Φ105	Φ130	
	Spindle head type	/	A1-11	A2-15	
	Spindle speed	rpm	20~1000(4 class, hydraulic automatic class switch, stepless speed in every class) I 20~204, II 39~354, III 71~642, IV 124~1000	3.5~500(4 class, hydraulic automatic class switch, stepless speed in every class) I 3.5~160, II 5~233, III 7~345, IV 11~500	
	Spindle motor	kw	15(servo)	22(servo)	
	Chuck size	mm	Φ315(Manual 3-jaw chuck)	Φ630(Manual 3-jaw chuck)	
X/Z axes	X axes travel	mm	430	520	
	Z axes travel	mm	760/1350/1850/2850/3850	1300/2800	
	X/Z axes rapid speed	m/min	6/7	3/6	
	X axes ball screw O.D./pitch	mm	Φ40/5	Φ40/6	
	Z axes ball screw O.D./pitch	mm	Φ50/8(1000,1500), Φ63/8(2000,3000),Φ63/10(4000)	Φ63/10	
Tool post	Tool turret type	/	Vertical 4 station electric tool turret	Vertical 4 station electric tool turret	
	Tool shank size	mm	32×32	40×40	
	Tailstock quill dia.	mm	Φ100(1000,1500,2000,3000),Φ140(4000)	Φ160	
Tailstock	Tailstock quill travel	mm	250(1000,1500,2000,3000),200(4000)	300	
	Tailstock quill taper	/	MT5#(1000,1500,2000,3000),MT6#(4000)	MT6#	
	X/Z axes positioning accuracy	mm	0.026/0.036(1000),0.040(1500,2000), 0.048(3000),0.056(4000)	0.040/0.050(1500),0.060(3000)	
Accuracy	X/Z axes repeatability positioning accuracy	mm	0.007/0.011(1000),0.014(1500, 2000), 0.020(3000,4000)	0.011/0.018(1500),0.025(3000)	
	Turning workpiece roundness	mm	0.004	0.01	
Others	Total power	KVA	40	40	
	N.W.	kg	7200/8000/8600/9600/11000	10500/12500	
	Overall size(L×W×H)	mm	4280×2200×1900 (1000)	4880×2200×1900 (1500)	4640×2300×2100(1500)
		mm	5800×2260×1900 (2000)	6850×2260×1900 (3000)	6150×2650×2290(3000)
mm		6850×2260×1900 (3000)	7700×2350×1900 (4000)		
mm		7700×2350×1900 (4000)			

* The marked accuracy just follows CHINA national standard GB/T 25659.1, actual accuracy is much higher

Main parts list:		Standard configuration:	Optional configuration:
Spindle bearing	CHINA top	●FANUC 0i TF CNC Controller	●SIEMENS 808D/GSK980TDI
Ball screw bearing	CHINA top	●Manual 3-jaw chuck	●Steady rest
Ball screw	CHINA top	●4 station tool post	●Follow rest
Lubrication pump	JAPAN-LUBE	●Manual Tailstock	



FLAT BED CNC LATHE CKL STANDARD SERIES

BL-CKL6163/6180A/6180B/61100

550/600MM GUIDEWAY WIDTH, SPINDLE BORE: 104MM

BLIN Ideal for machinery solution



CKL6180B 1500mm

Features:

- Guideway width 550/600mm, spindle bore $\Phi 104$ mm, heavy-duty type, suitable for heavy cutting
- Adopt China top quality compound resin sand cast iron, after aging treatment, good precision keeping
- Guideway hardened by ultrasonic frequency, good precision keeping, long using lifespan
- Guideway stick PTFE, remove creeping, good wearability
- Adopt Manual 3 class gear spindle, stepless speed in every class, can also choose Hydraulic 4 class

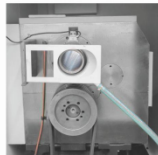

Manual 3 class gear spindle



Manual chuck



Follow rest and 4T tool post



Strong tailstock and steady rest



Electricity cabinet

Specification:						
Item	Specification	Unit	BL-CKL6163	BL-CKL6180A	BL-CKL6180B	BL-CKL61100
Capacity	Guideway width	mm	550		600	
	Max. swing dia. over bed	mm	$\Phi 630$	$\Phi 800$	$\Phi 800$	$\Phi 1000$
	Max. swing dia. over slide	mm	$\Phi 350$	$\Phi 520$	$\Phi 480$	$\Phi 680$
	Center distance	mm	1000/1500/2000/3000/4000/5000/6000			
	Max. loading capacity	t	3		4	
Spindle	Spindle bore	mm	$\Phi 104$			
	Spindle bore taper	/	Metric $\Phi 120$ MT5#			
	Spindle speed	rpm	10-1000 (manual 3 class gears, stepless in every class);		10-800 (manual 3 class gears, stepless in every class);	
	Spindle nose type	/	C11			
	Chuck size	mm	Manual 3-jaw $\Phi 315$		Manual 3-jaw $\Phi 400$	
Feeding axes	Spindle motor	kw	11		15	
	X axes travel	mm	320	420	420	520
	Z axes travel	mm	850/1350/1850/2850/3850/4850/5850			
Tool post	X/Z axes rapid rate	m/min	4/6			
	Tool post type	mm	4 station electric tool post			
	Toolshank size	mm	32×32	32×32	32×32	40×40
Tailstock	Tailstock quill travel	mm	250			
	Tailstock quill dia.	mm	$\Phi 100$		$\Phi 120$	
	Tailstock quill taper	/	MT5#		MT6#	
Overall size	L	mm	3300/3800/4300/5300/6300/7300/8300		3500/4000/4500/5500/6500/7500/8500	
	W×H	mm	1750×1850	1850×1900	1950×1900	2000×2100
Others	N.W.	T	3.7/4.1/4.5/5.3/ 6.1/6.9/7.7	3.9/4.3/4.7/5.5/ 6.3/7.1/7.9	4.8/5.2/5.6/6.4/ 7.2/8/8.8	5/5.4/5.8/6.6/ 7.4/8.2/9

Standard configuration:

- GSK controller
- Manual chuck
- 4 station tool post
- Manual tailstock

Optional configuration:

- SIEMENS 808D ADVANCED/FANUC 0i TF controller
- Hydraulic chuck
- 6/8 station tool turret
- Hydraulic tailstock



FLAT BED CNC LATHE CK HEAVY-DUTY SERIES

BL-CK61100/61125/61140/61160

755MM GUIDEWAY WIDTH, SPINDLE BORE: 130MM

BLIN Ideal for machinery solution

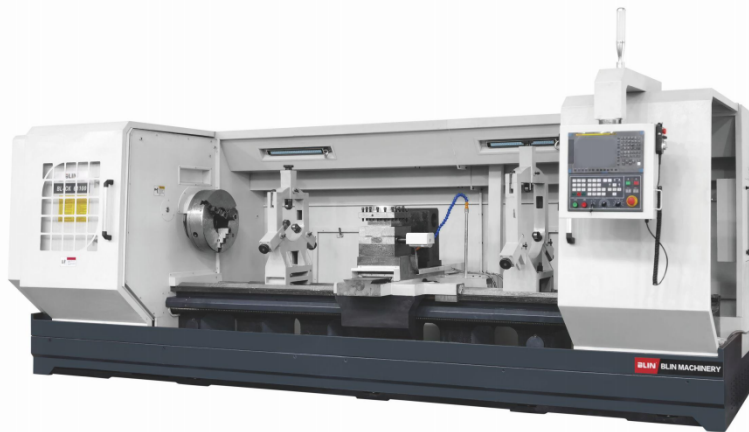

CK61100 3000mm

Features:

- Guideway width 755mm, spindle bore Φ 130mm, heavy-duty type, suitable for heavy cutting
- Mono-block bed, high rigidity
- Adopt China top quality compound resin sand cast iron, after aging treatment, good precision keeping
- Guideway hardened by ultrasonic frequency, good precision keeping, long using lifespan
- Guideway stick PTFE, remove creeping, good wearability
- Adopt manual 4 class gear spindle, stepless speed in every class

Specification:

Item	Specification	Unit	BL-CK61100	BL-CK61125	BL-CK61140	BL-CK61160
Capacity	Guideway width	mm	755			
	Max. swing dia. over bed	mm	Φ 1000	Φ 1250	Φ 1400	Φ 1600
	Max. swing dia. over slide	mm	Φ 610	Φ 850	Φ 1000	Φ 1200
	Center distance	mm	1500/3000/4000/5000/6000			
	Max. loading capacity	t	6			
Spindle	Spindle bore	mm	Φ 130			
	Spindle bore taper	mm	Metric Φ 140/MT6#			
	Spindle speed	rpm	4-300(manual 4 class gears, speed stepless in every class)			
	Spindle nose type	/	A2-15			
	Chuck size	mm	Manual 4-jaw Φ 1000mm			
	Spindle motor	kw	22			
Feeding axes	X axes travel	mm	520	620	720	720
	Z axes travel	mm	1350/2850/3850/4850/5850			
	X/Z axes rapid rate	m/min	4/6			
Tool post	Tool post type	mm	4 station electric tool post			
	Toolshank size	mm	40×40			
Tailstock	Tailstock quill travel	mm	300			
	Tailstock quill dia.	mm	Φ 160			
	Tailstock quill taper	/	MT6#			
Overall size	L	mm	5000/6500/7500/8500/9500			
	W×H	mm	2100×2100	2250×2300	2350×2450	2350×2600
Others	N.W.	T	10/11.5/12.5/13.5/14.5	11/12.5/13.5/14.5/15.5	12/13.5/14.5/15.5/16.5	13/14.5/15.5/16.5/17.5

Standard configuration:

- GSK controller
- Manual chuck
- 4 station tool post
- Manual tailstock

Optional configuration:

- SIEMENS 808D ADVANCED/FANUC 0i TF controller
- 6/B station tool turret
- Hydraulic tailstock



FLAT BED CNC LATHE CKW HEAVY-DUTY SERIES

BL-CKW61125/61140/61160/61180/61200

1100MM GUIDEWAY WIDTH, SPINDLE BORE: 100MM

BLIN Ideal for machinery solution



CKW61125

Features:

- Guideway width 1100mm, spindle bore Φ 100mm, heavy-duty type, suitable for heavy cutting
- Mono-block bed, high rigidity
- Adopt China top quality compound resin sand cast iron, after aging treatment, good precision keeping
- Guideway hardened by ultrasonic frequency, good precision keeping, long using lifespan
- Guideway stick PTFE, remove creeping, good wearability
- Adopt manual 4 class gear spindle, stepless speed in every class

Specification:

Item	Specification	Unit	CKW61125	CKW61140	CKW61160	CKW61180	CKW61200
Capacity	Guideway width	mm	1100				
	Max. swing dia. over bed	mm	Φ 1250	Φ 1440	Φ 1640	Φ 1840	Φ 2020
	Max. swing dia. over slide	mm	Φ 710	Φ 820	Φ 1020	Φ 1220	Φ 1420
	Center distance	mm	3000-10000				
	Max. loading capacity	t	10/20/30				
Spindle	Spindle bore	mm	Φ 100				
	Spindle bore taper	/	Metric 120				
	Spindle speed	rpm	Manual 4 class gears, speed stepless in every class				
			10-300	10-300	10-300	10-200	10-200
	Spindle nose type	/	A2-15				
	Chuck size	mm	Manual 4-jaw Φ 1250mm			Manual 4-jaw Φ 1400mm	
Feeding axes	Spindle motor	kw	37				
	X axes travel	mm	700	750	830	930	1020
	Z axes travel	mm	2850-9850				
Tool post	X/Z axes rapid rate	m/min	4/6				
	Tool post type	mm	4 station electric tool post				
	Toolshank size	mm	50x50				
Tailstock	Tailstock quill travel	mm	300				
	Tailstock quill dia.	mm	Φ 220				
	Tailstock quill taper	/	Metric 80				
Overall size	L	mm	6700-13700				
	WxH	mm	2550x2350	2600x2400	2700x2560	2800x2760	2900x2900
Others	N.W.	T	22.6-28.9	23.6-29.9	24.6-30.9	25.6-31.9	26.6-32.9

Standard configuration:

- GSK controller
- Manual chuck
- 4 station tool post
- Manual tailstock

Optional configuration:

- FANUC Oi TF controller
- 6/B station tool turret
- Hydraulic tailstock



CNC PIPE THREADING LATHE QK STANDARD SERIES

BL-QK1313/1319/1322/1325/1327A

550/600MM GUIDEWAY WIDTH, SPINDLE BORE:130/200/225/255/280MM, HIGH QUALITY

BLIN Ideal for machinery solution

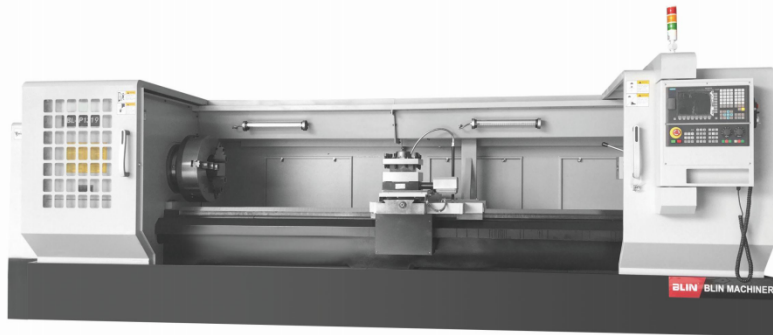

QK1319 3000MM

Features:

- Guideway width 550/600mm
- Suitable to process internal thread and external thread of pipes, can be also used as standard cnc lathe
- Adopt China top quality compound resin sand cast iron, after aging treatment, good precision keeping
- Guideway hardened by ultrasonic frequency, good precision keeping, long using lifespan
- Guideway stick PTFE, remove creeping, good wearability
- Adopt gear spindle, stepless speed in every class

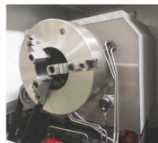

Spindle double chucks



Manual gear spindle

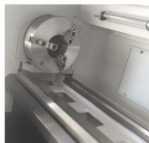

Strong guideway



4 station tool turret



Strong tailstock

Specification:							
Item	Specification	Unit	BL-QK1313	BL-QK1319	BL-QK1322	BL-QK1325	BL-QK1327A
Capacity	Guideway width	mm	550			600	
	Max. swing dia. over bed	mm	Φ630/800			Φ800	
	Max. swing dia. over slide	mm	Φ340/520			Φ480	
	Center distance	mm	1000/1500/3000				
	Pipe threading range	mm	Φ30-Φ126	Φ50-Φ193	Φ50-Φ220	Φ50-Φ250	Φ50-Φ270
	Max. loading capacity	t	3			4	
Spindle	Spindle bore	mm	Φ130	Φ200	Φ225	Φ255	Φ280
	Spindle speed steps	/	Manual 3 class, stepless	Manual 4 class, stepless	Manual 4 class, stepless	Manual 4 class, stepless	Manual 4 class, stepless
	Spindle speed range	rpm	30-720	20-550	20-550	20-420	20-420
	Chuck size	mm	Manual 3-jaw Φ400	Manual 3-jaw Φ500	Manual 3-jaw Φ500	Manual 4-jaw Φ630	Manual 4-jaw Φ800
	Spindle motor	kw	11			15	
Feeding axes	X axes travel	mm	320/420			420	
	Z axes travel	mm	850/1350/2850				
	X/Z axes rapid rate	m/min	4/6				
Tool post	Tool post type	mm	4 station electric tool post				
	Toolshank size	mm	32×32				
Tailstock	Tailstock quill travel	mm	250				
	Tailstock quill dia.	mm	Φ100			Φ120	
	Tailstock quill taper	/	MT5#			MT6#	
Others	Overall size	mm	3300/3800/5300×1880×1850			3600/4100/5600×1930×1900	
	N.W.	T	4.5/5/6	4.6/5.1/6.1	4.7/5.2/6.2	6/6.5/7.5	6.2/6.7/7.7

Standard configuration:

- GSK980TC3 CNC controller
- Double Manual chuck
- 4 station tool post
- Manual tailstock

Optional configuration:

- SIEMENS 808D ADVANCED/FANUC 0i TF controller
- 6/8 station tool turret



CNC PIPE THREADING LATHE QK HEAVY-DUTY SERIES

BL-QK1327B/1332/1338/1343/1350/1363

755/1100MM GUIDEWAY WIDTH, SPINDLE BORE:280/330/390/440/520/640MM, HIGH QUALITY

BLIN Ideal for machinery solution

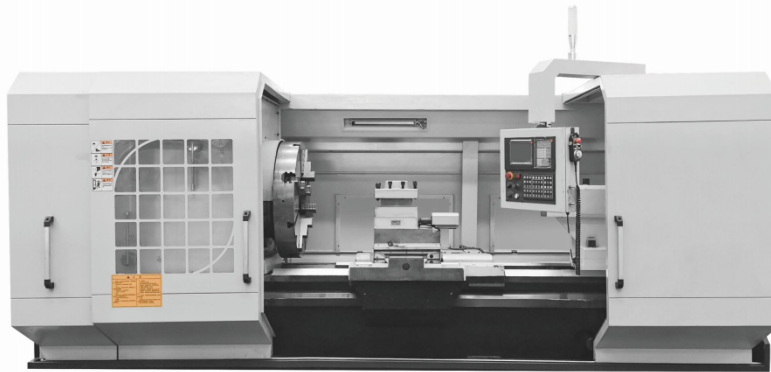

QK1338

Features:

- Guideway width 755/1100mm
- Suitable to process big size internal and external pipe thread, can be also used as standard cnc lathe
- Adopt China top quality compound resin sand cast iron, after aging treatment, good precision keeping
- Guideway hardened by ultrasonic frequency, good precision keeping, long using lifespan
- Guideway stick PTFE, remove creeping, good wearability
- Adopt gear spindle, stepless speed in every class

Specification:								
Item	Specification	Unit	BL-QK1327B	BL-QK1332	BL-QK1338	BL-QK1343	BL-QK1350	BL-QK1363
Capacity	Guideway width	mm	755	755	755	755	755	1100
	Max. swing dia. over bed	mm	Φ1000	Φ1000	Φ1000	Φ1000	Φ1200	Φ1400
	Max. swing dia. over slide	mm	Φ610	Φ610	Φ610	Φ610	Φ710	Φ800
	Center distance	mm	1500/3000(can be especially ordered for other length)					
	Pipe threading range	mm	Φ130~Φ270	Φ190~Φ320	Φ190~Φ380	Φ270~Φ430	Φ330~Φ510	Φ330~Φ630
Spindle	Max. loading capacity	t	6	6	6	6	6	10
	Spindle bore	mm	Φ280	Φ330	Φ390	Φ440	Φ520	Φ640
	Spindle speed steps	/	Manual 4 class, stepless	Manual 3 class, stepless	Manual 3 class, stepless	Manual 3 class, stepless	Manual 3 class, stepless	Manual 3 class, stepless
	Spindle speed range	rpm	10~320	10~280	8~205	8~205	8~190	2~120
Feeding axes	Chuck size	mm	Manual 4-jaw Φ800	Electric 4-jaw Φ780	Electric 4-jaw Φ800	Electric 4-jaw Φ1000	Electric 4-jaw Φ1000	Manual 4-jaw Φ1250
	Spindle motor	kw	22	22	22	22	22	37
	X axes travel	mm	520	520	520	520	520	750
	Z axes travel	mm	1250/Z750					
	X/Z axes rapid rate	m/min	4/4					
Tool post	Tool post type	mm	4 station electric tool post					
	Toolshank size	mm	40×40	40×40	40×40	40×40	50×50	50×50
	Tailstock quill travel	mm	300					
Tailstock	Tailstock quill dia.	mm	Φ160	Φ160	Φ160	Φ160	Φ160	Φ220
	Tailstock quill taper	/	MT6#	MT6#	MT6#	MT6#	MT6#	Metric 80
	Overall size	mm	4950/6450×2050×2050	5000/6500×2080×2080	5000/6500×2220×2120	5000/6500×2220×2120	5000/6500×2300×2200	5600/7100×2500×2500
Others	N.W.	T	10.5/12.2	11.5/12.5	12/13	13/14	15/16	18/19.3

Standard configuration:

- GSK980TDi controller
- Dual Manual chuck
- 4 station tool post
- Manual tailstock

Optional configuration:

- SIEMENS 808D ADVANCED/FANUC 0i TF controller



CONVENTIONAL LATHE B PRECISE HEAVY-DUTY SERIES

BL-HL-B40/50/66/80

390MM GUIDEWAY WIDTH, CHINA TOP QUALITY

BLIN Ideal for machinery solution

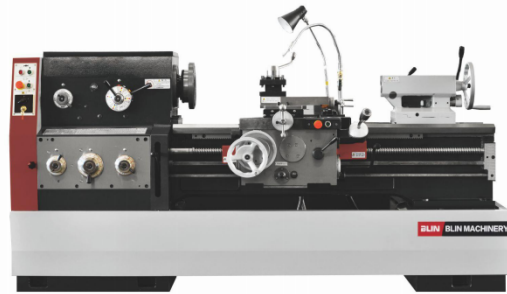

24 class speed

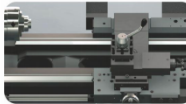

High quality guideway



Operation handle



Strong tailstock

Features:

- Guideway width 390mm
- Adopt high strength cast iron, after repeated aging treatment
- Guideway is hardened by ultrasonic frequency and precise grinding
- Headstock is after precise machining, spindle and gears are hardened by ultrasonic frequency and precise grinding
- Guideway adopt scrapping and stick TF material
- Wide speed range, can directly turn metric or inch thread
- Can mount Gap

Specification:						
Item	Specification	Unit	BL-HL-B40	BL-HL-B50	BL-HL-B66	BL-HL-B80
Capacity	Guideway width	mm	390			
	Max. swing dia. over bed	mm	Φ400	Φ500	Φ660	Φ800
	Max. swing dia. over cross slide	mm	Φ220	Φ300	Φ420	Φ560
	Max. swing dia. over gap	mm	Φ630	Φ710	Φ870	Φ1000
	Max. effective length in gap	mm	240			
	Center distance	mm	750/1000/1500/2000/3000		2000/3000	
	Max. turning length	mm	700/950/1450/1950/2950		1950/2950	
Spindle	Max. feeding force	Nm	3500			
	Spindle bore	mm	Φ52(Opt. Φ82, Φ105)		Φ82(Opt. Φ105)	
	Spindle hole taper	/	MT6#(Φ52mm bore), Φ90 1:20(Φ82mm bore), Φ113 1:20(Φ105mm bore)			
	Spindle nose	/	ISO 702/II NO.6(Φ52mm bore), ISO 702/II NO.8(Φ82, 105mm bore)		ISO 702/III NO.6(Φ82mm bore), ISO 702/II NO.8(105mm bore)	
	Spindle speed range	rpm	9~1600(24 steps, for Φ52,82mm bore), 36~1600(12steps, for Φ105mm bore)		8~1400(24 steps, for Φ82mm bore), 30~1400(12steps, for Φ105mm bore)	
	Spindle max. output torque	Nm	1400	1400	1200	/
	Longitudinal rapid moving speed	m/min	50hz:4.5, 60hz:5.4			
Feeding	Cross rapid moving speed	m/min	50hz:1.9, 60hz:2.3			
	Longitudinal basical feeding	mm/r	0.063~2.52(65kinds)		0.028~6.43(93 kinds)(for 82mm bore); 0.063~2.52(65kinds)(for 105mm bore)	
	Longitudinal reduce feeding	mm/r	0.028~0.056(13 kinds)			
	Longitudinal enlarge feeding	mm/r	2.86~6.43(15 kinds)			
	Cross basical feeding	mm/r	0.027~1.07(65 kinds)		0.012~2.73(93 kinds)(for 82mm bore); 0.027~1.07(65 kinds)(for 105mm bore)	
	Cross reduce feeding	mm/r	0.012~0.026(13 kinds)			
	Cross enlarge feeding	mm/r	1.21~2.73(15 kinds)			
Tool post	Upper tool post travel	mm	145			
	Lower tool post travel	mm	320	320	310	320
	Tool qty	/	4			
	Toolshank size	mm	25×25			
	Distance from spindle center to tool support face	mm	28			
	Max rotary angle scale of square tool post	/	±90°			
Thread	Metric thread	mm	0.5~224(48kinds)(for Φ52,82mm bore), 1~14(22kinds)(for Φ105mm bore)			
	Inch thread	TPI	72~1/8(46kinds)(for Φ52,82mm bore), 28~2(25kinds)(for Φ105mm bore)			
	Module thread	M.P.	0.5~112(42kinds)(for Φ52,82mm bore), 0.5~7(18kinds)(for Φ105mm bore)			
	Diametrical pitch thread	D.P.	56~1/4(45kinds)(for Φ52,82mm bore), 56~4(24kinds)(for Φ105mm bore)			
Tailstock	Travel of tailstock quill	mm	150			
	Dia. of tailstock quill	mm	Φ75		Φ90	
	Taper of tailstock quill	/	MT5#			
Motor	Tailstock cross movement	mm	±15			
	Spindle motor power/speed	/	7.5kw, 1450r/min(50Hz); 1750r/min(60Hz)			
	Rapid movement motor power	/	0.3kw, 1360r/min(50Hz); 1750r/min(60Hz)			
	Coolant motor power	kw	0.15			
Others	Coolant pump flow	L/min	25			
	Weight	kg	1975/2050/2250/2450/2850	2050/2100/2300/2500/2900	2150/2200/2400/2600/3000	3300/3700
	Machine length	mm	2380/2630/3130/3630/4630		3365/4365	
	Machine width×height	mm	975×1230	975×1270	975×1350	1340×1490



CONVENTIONAL LATHE B PRECISE HEAVY-DUTY SERIES BL-HL-B63B/80A

560MM GUIDEWAY WIDTH, CHINA TOP QUALITY

BLIN Ideal for machinery solution



BL-HL-B80A

Features:

- Guideway width 560mm, suitable for heavy cutting
- Adopt high strength cast iron, after repeated aging treatment
- Guideway is hardened by ultrasonic frequency and precise grinding
- Headstock is after precise machining, spindle and gears are hardened by ultrasonic frequency and precise grinding
- Guideway adopt scraping and stick TF material
- Wide speed range, can directly turn metric or inch thread
- Can mount Gap



14 class speed

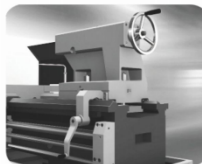

Strong tailstock

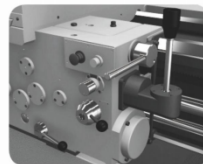

*+ operation handle

Specification:				
Item	Specification	Unit	BL-HL-B63B	BL-HL-B80A
Capacity	Guideway width	mm	560	
	Max. swing dia. over bed	mm	Φ660	Φ830
	Max. swing dia. over cross slide	mm	Φ400	Φ540
	Max. swing dia. over gap	mm	Φ800	Φ970
	Chuck size	mm	Φ315	
	Center distance	mm	1500/2000/3000/4000(only 1500mm can mount gap)	
	Max. turning length	mm	1400/1900/2900/3900	
Spindle	Gap effective length	mm	300	
	Spindle bore	mm	Φ105	
	Spindle hole taper	/	Metric 1:20	
	Spindle head type	/	A1-11	
	Spindle speed range	rpm	12.5~1120(14steps)	
	Longitudinal feeding range	mm/r	0.062~14.0(64 kinds)	
	Cross feeding range	mm/r	0.031~7.0(64 kinds)	
Feeding and thread	Upper tool post travel	mm	200	
	Lower tool post travel	mm	480	515
	Toolshank size	mm	32×32	
	Metric thread	mm	0.5~56(38kinds)	
	Inch thread	TPI	56~0.5(43kinds)	
	Module thread	M.P.	0.25~7(21kinds)	
	Diametrical pitch thread	D.P.	56~4(27kinds)	
Tailstock	Travel of tailstock quill	mm	250	
	Dia. of tailstock quill	mm	Φ100	
	Taper of tailstock quill	/	MT5#	
Others	Spindle motor power	kw	11	
	Coolant motor power	kw	0.18	
	Weight	kg	4200/4500/5000/5800	4500/4800/5300/6100
	Overall size(L×W×H)	mm	3500/4000/5000/6000×1260×1385	3500/4000/5000/6000×1370×1470